

Specification

Piezoelectric Ceramic Element

Part No: ANN-P5AHF20080

Unit: mm

Dimension: $\Phi 20 \times 0.8$

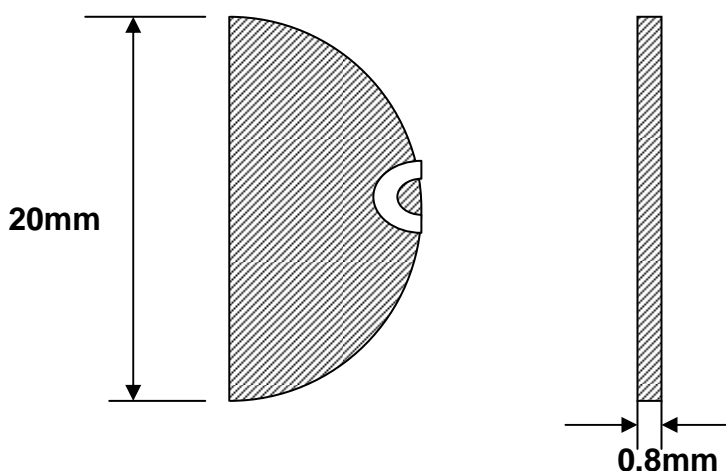

Material: PZT-5A

Type: Half-Moon

Electrical Characteristics:

1. Diameter	: 20mm
2. Thickness	: 0.8mm
3. Capacitance	: 3550 pf \pm 12.5%
4. Thickness Frequency	: 2.5MHz \pm 5%
5. Dielectric loss (tg δ)	: \leq 2.3%
6. piezoelectric charge constant (d33)	: 400×10^{-12} C/N
7. Coupling Factor (Kp)	: 0.65
8. Coupling Factor (Kt)	: 0.43