

Specification

Piezoelectric Ceramic Element

Part No: ANN-P5AF2001

Unit: mm

Dimension: $\Phi 20 \times 1$

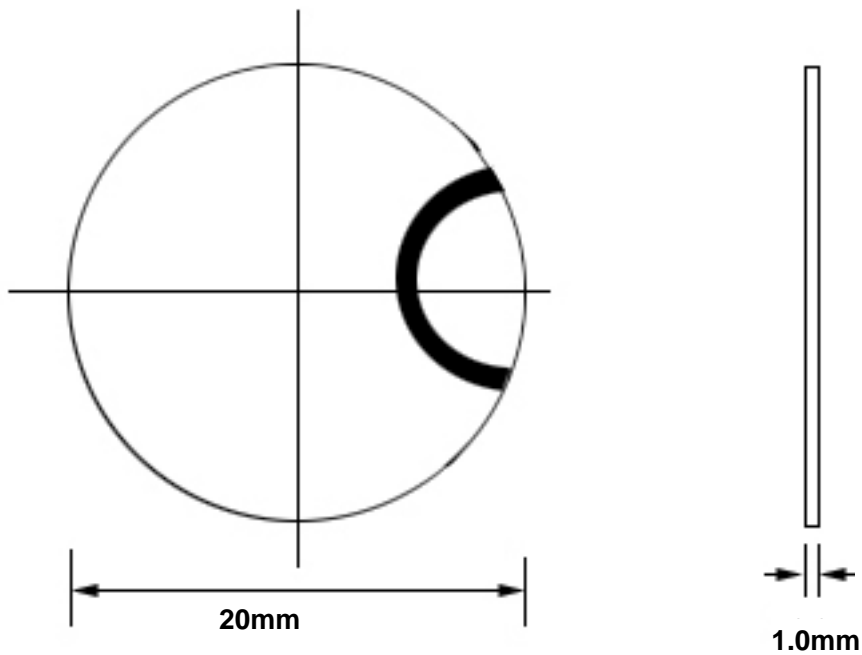

Piezoelectric material : PZT-5A

Electrical Characteristics:

- | | |
|--|-----------------------------|
| 1. Thickness Frequency | : 2.0MHz \pm 5% |
| 2. Capacitance | : 3560pf \pm 12.5% |
| 3. Coupling Factor(Kt) | : 0.43 |
| 4. Coupling Factor (Kp) | : 0.66 |
| 5. piezoelectric charge constant (d33) | : 420 $\times 10^{-12}$ C/N |
| 6. Courier temperature | : 350 $^{\circ}$ C |