

Specification

Piezoelectric Ceramic Element

Part No: ANN-P4421505

Unit: mm

Dimension: $\Phi 42 \times \Phi 15 \times 5$

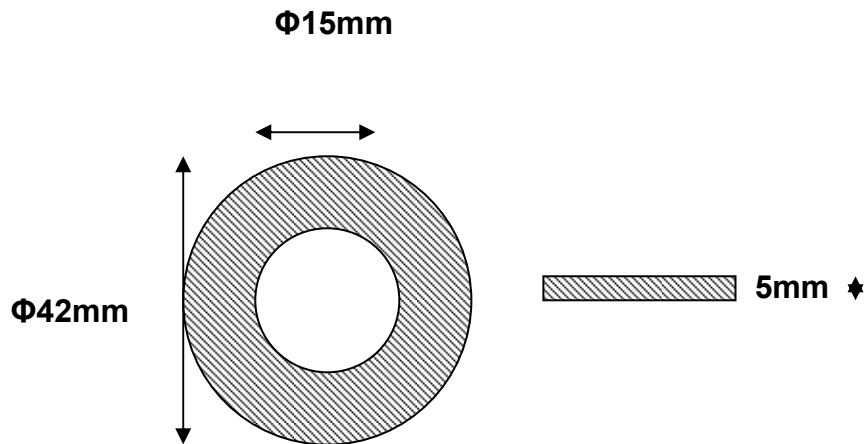

Piezoelectric Material: PZT-4

Electrical Characteristics:

1. Radial Frequency (fr)	: 40KHz \pm 5%
2. Capacitance (C)	: 1970 pf \pm 12.5%
3. Dielectric loss (tg δ)	: \leq 0.5%
4. Resistance (Zm)	: \leq 15 Ω
5. Coupling coefficient (Kr)	: \geq 0.55
6. Mechanical quality factor (Qm)	: \geq 500
7. Density (ρ)	: 7.5×10^3 kg/m ³