

Specification

Piezoelectric Ceramic Element

Part No: ANN-P4F50035

Unit: mm

Dimension: $\Phi 50 \times 3.5$ (mm)

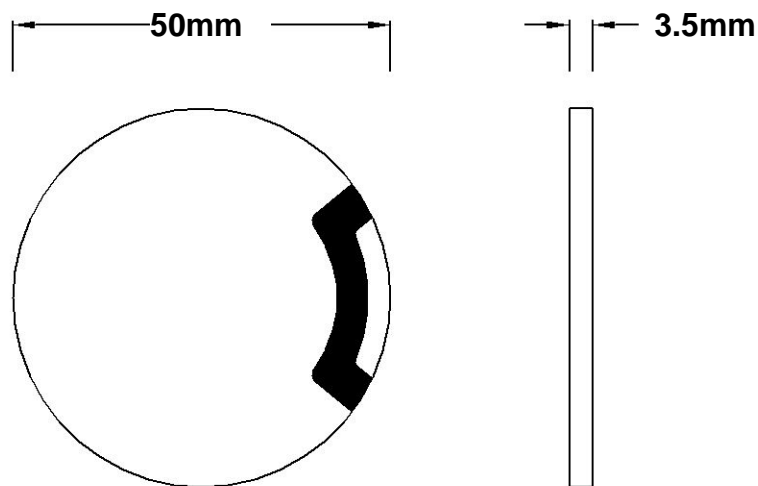

Piezoelectric Material: PZT-4

Silver Electrodes: on the same side

Electrical Characteristics:

1. Radial Frequency (fs)	: 46.0±5% KHz
2. Capacitance (C)	: 6300 pf±12.5%
3. Impedance	: $\leq 15\Omega$
4. Electromechanical coupling coefficient (Kr)	: ≥ 0.54
5. Dielectric dissipation factor ($\tan\delta$)	: ≤ 0.50
6. Piezoelectric charge coefficient (d_{33})	: $250 \times 10^{-12} \text{C/N}$
7. Mechanical quality factor (Q_m)	: ≥ 500
8. Curie temperature (T_c)	: 310°C

ANNON PIEZO TECHNOLOGY CO., LIMITED.

ADDRESS: ROOM 1701 TOP OFFICE, GILITTERY CITY, NO.3027 SHENNAN RD CENTRAL, SHENZHEN CITY, CHINA.

PHONE: +86-0755-83038178

FAX: +86-0755-83038785

Website: <http://www.annon-piezo.com>

EMAIL: sales@annon-piezo.com