

Specification

Piezoelectric Ceramic Element

Part No: ANN-P4F28020

Unit: mm

Dimension: $\Phi 28 \times 2$ (mm)

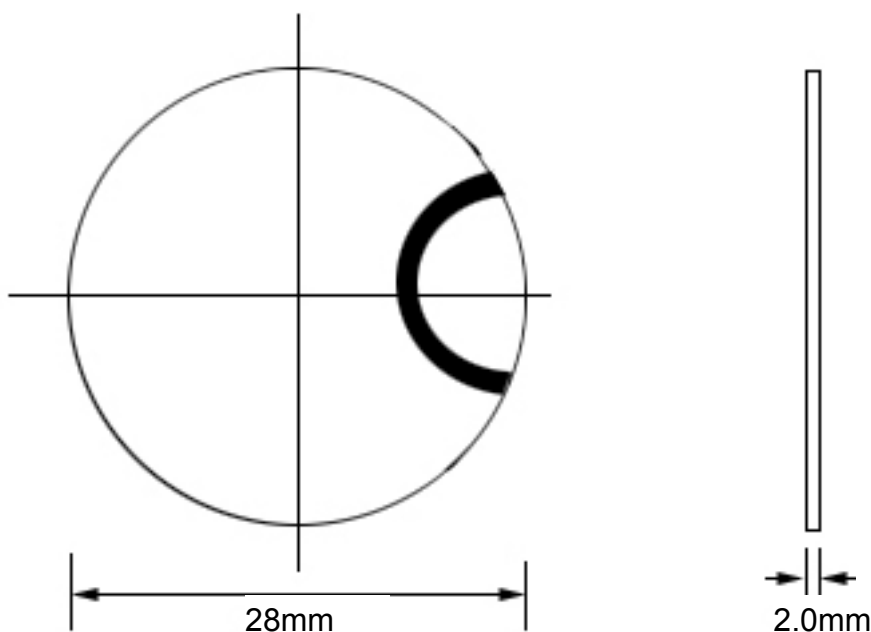

Piezoelectric Material: PZT-4

Silver Electrodes: on the same side

Characters:

1. Thickness Frequency (fr)	: 1.0MHz \pm 5%
2. Capacitance (C)	: 3300 pf \pm 12.5%
3. Resistance	: $\leq 2 \Omega$
4. Electrical-mechanical coupling coefficient (Kt)	: $\geq 45\%$
5. Dielectric loss (tg δ)	: $\leq 0.3\%$
6. Mechanical quality factor (Qm)	: ≥ 500
7. Curie temperature (Tc)	: 320 $^{\circ}$ C