

## Specification

Piezoelectric Ceramic Element

Part No: ANN-P4F25020

Unit: mm

Dimension:  $\Phi 25 \times 2$  (mm)

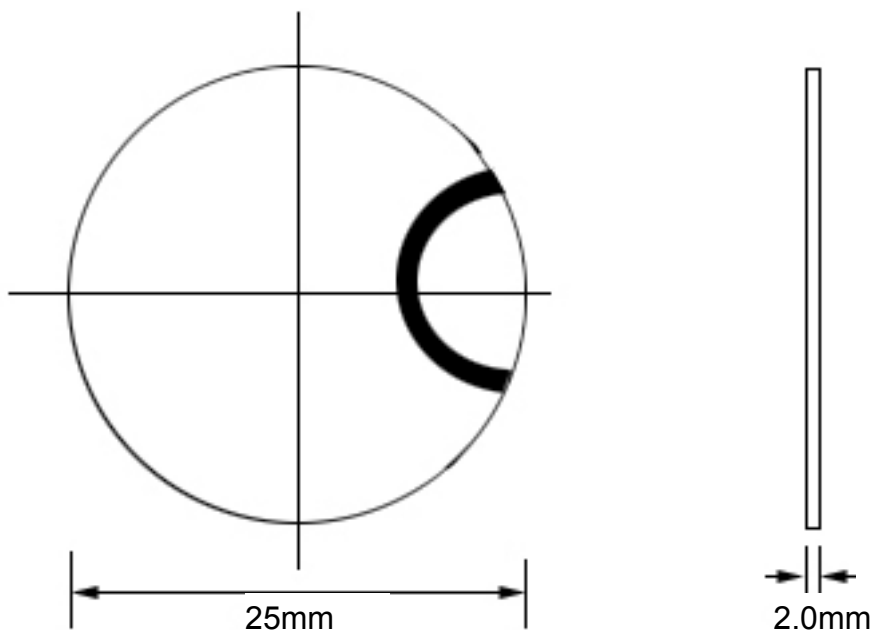

**Piezoelectric Material: PZT-4**

**Silver Electrodes: on the same side**

**Characters:**

1. Thickness Frequency (fr)	: 1.0MHz $\pm$ 5%
2. Capacitance (C)	: 2700 pf $\pm$ 12.5%
3. Resistance	: $\leq 2 \Omega$
4. Electrical-mechanical coupling coefficient (Kt)	: $\geq 45\%$
5. Dielectric loss (tg $\delta$ )	: $\leq 0.3\%$
6. Mechanical quality factor (Qm)	: $\geq 500$
7. Curie temperature (Tc)	: 320 $^{\circ}$ C